

Take a large rectangle of thin paper and cut the upper triangle off as shown.

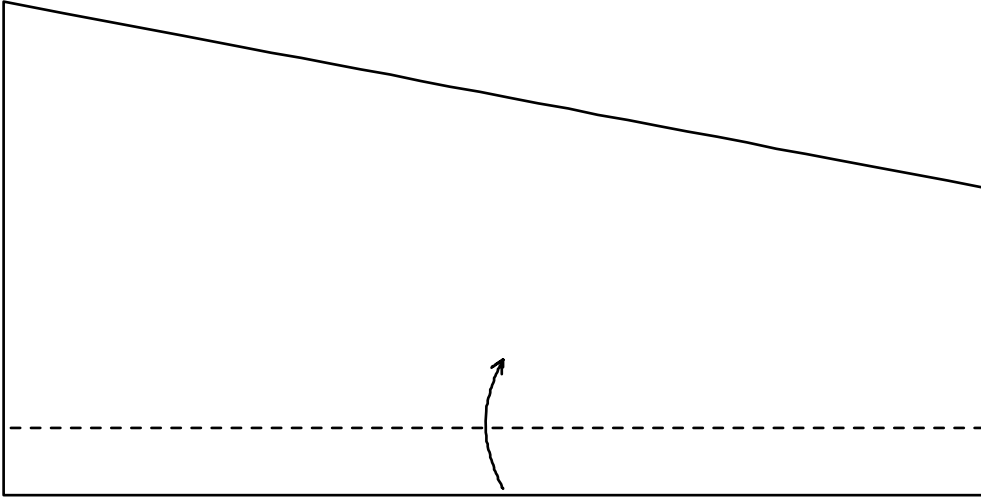

Vally fold the lower edge up.

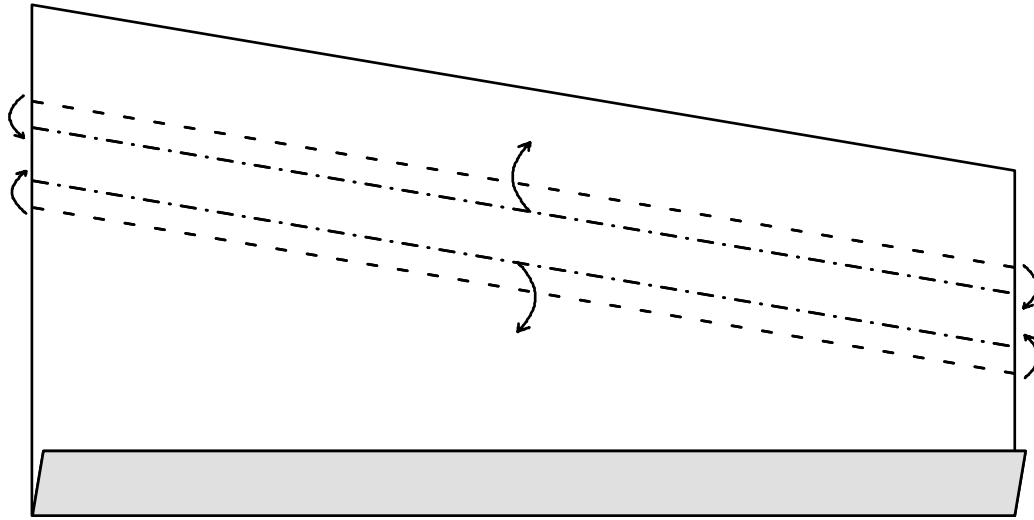

Insert pleats.

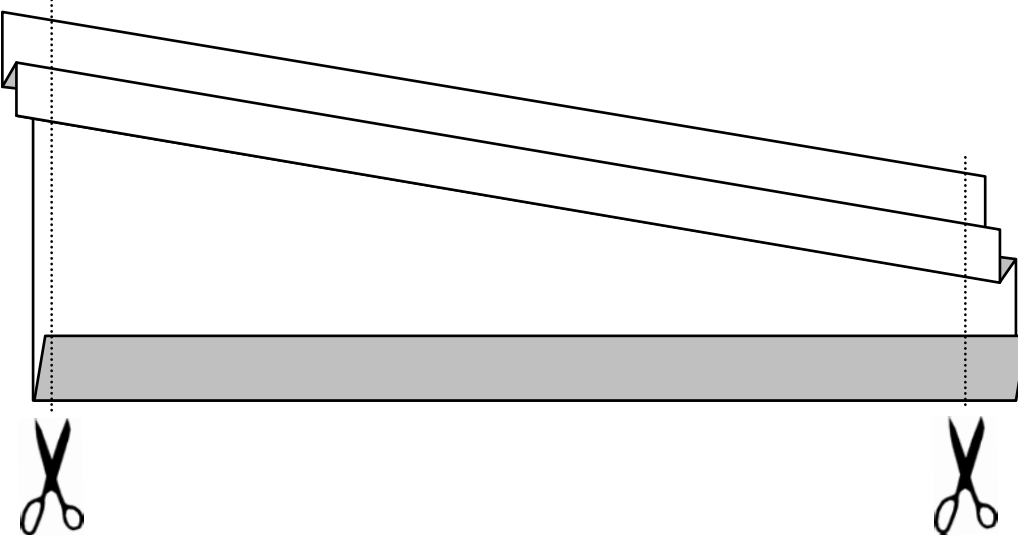

Cut the borders away.

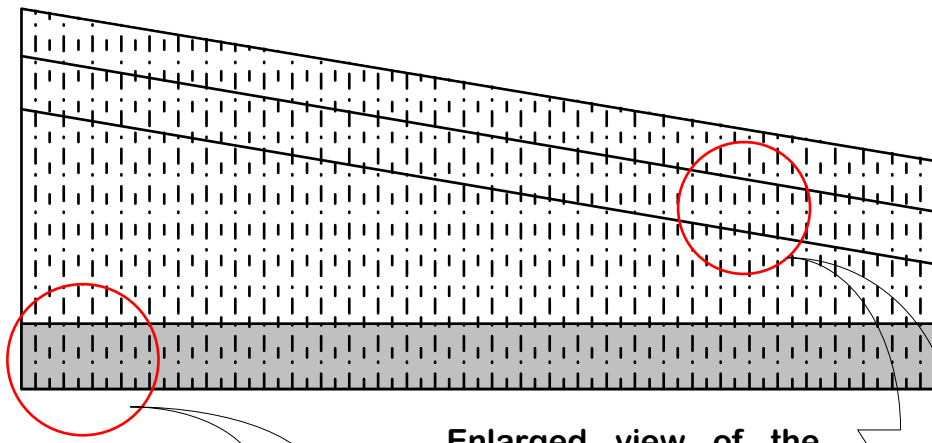

Divide the long side of the paper in 64th or more by dividing in half and in half again and again ....

Enlarged view of the shown areas.

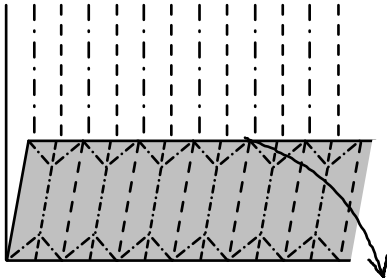

Valley fold to 90 degrees.

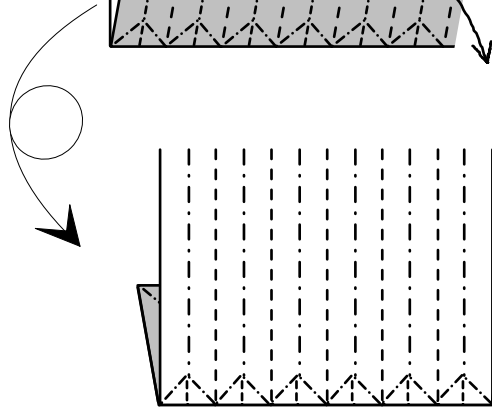
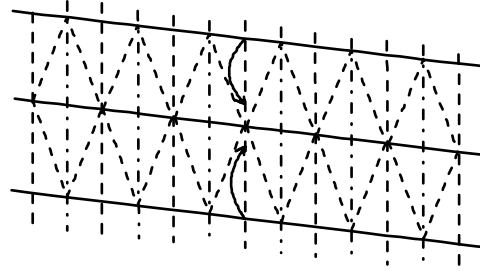

Valley fold the little triangles up.

Glue the sides of the model together and insert an energy-saving lamp.

